

OasisPure

Reverse osmosis water purifier

Model: FreshGO Flex

| User Manual

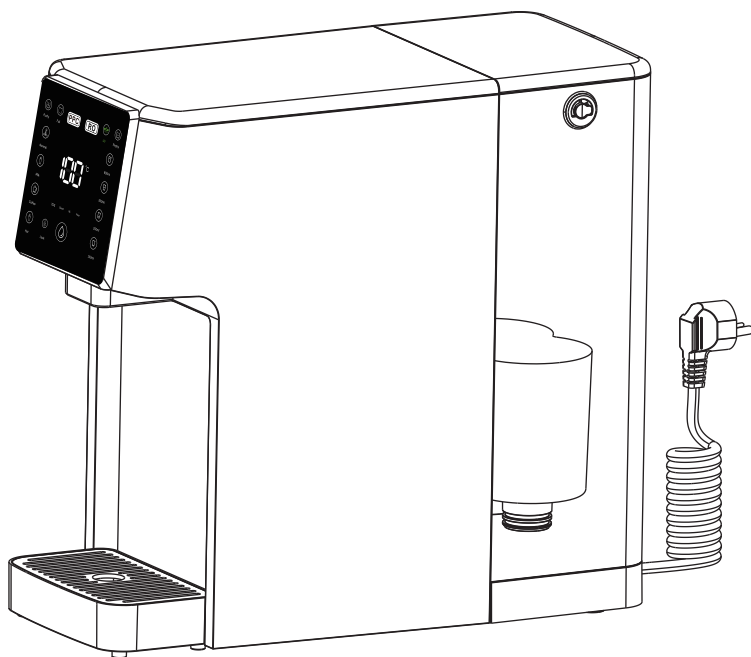

■ Thank you for your purchase and use. In order to bring you the best experience, please read the instruction manual carefully before installing, using and maintaining this product, and keep it for future reference.

■ Contents

Read before use	01
Precautions	01
Instructions for use	02
Care & Maintenance	08
Troubleshooting	10
Waterway Map	11
Product Specifications	12

■ Read before use

Respected User:

Thank you for choosing our company's RO water purifier.

Before you are ready to install and use this product, be sure to read this instruction manual in detail so that you can use and maintain the product in a more standardized manner.

The maintenance and replacement of the filter cartridges of the RO water purifier requires the use of parts approved by our company. The problems caused by the use of unauthorized parts or accessories, performance degradation or the damage to property are not covered by the manufacturer's warranty.

To avoid possible injury or property damage to you or others, be sure to observe the following safety precautions.

■ Precautions

1. Do not disassemble, repair or modify the machine by yourself, so as to avoid failure and danger, or even fire.
2. Children must operate under the guidance of adults to avoid burns.
3. Only connect the power cord to a power source that corresponds to the voltage rating indicated on the nameplate.
4. Do not use damaged power cords or plugs, and loose sockets.
5. Do not carry the machine by pulling on the power cord or plug.
6. Please use the standard municipal tap water as raw water.
7. If the purifier has not been used for more than 72 hours, when restarting, press and hold the  water output button for 3 seconds to empty all remaining water inside the machine; wait for the "Water full" icon to light up; (repeat the above 3 times).
8. When using for the first time, the water in the water tank may turn slightly white. This is a normal phenomenon, please feel free to use.
9. Different places have different water quality, and the service life of the filter cartridges may vary.
10. After replacing the new filter cartridge, before normal use please conduct cleaning operations as described in point 7.
11. When the machine needs to be cleaned, do not wipe it with a corrosive solution to avoid discoloration or corrosion on the surface of the machine.
12. If there is water leakage inside the machine, please disconnect the power plug and contact technical support.
13. If the product produces abnormal noise or emits a strange smell, please unplug it from the power outlet immediately, and then contact technical support.
14. If the power cord is damaged, it must be replaced by a professional from the manufacturer, its maintenance department or similar department in order to avoid danger.

■ Instructions For Use

1. Unpacking

Open the package, take out the manual, take out the upper foam, take the whole machine out of the box, and remove the plastic bag. Save the outer packaging for future shipping.

2. Part Name

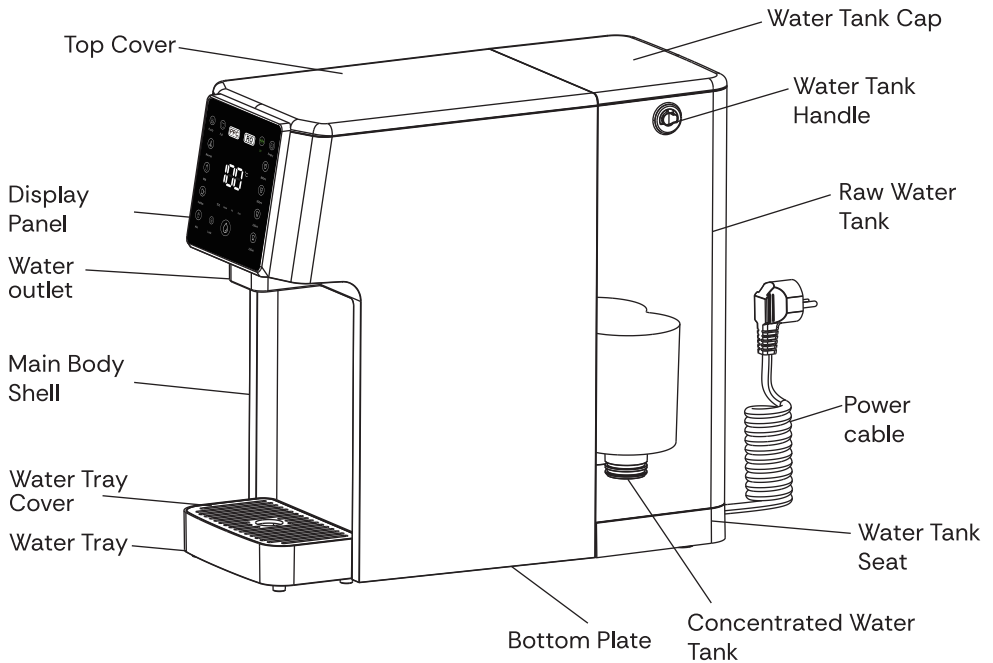



3. Packing Details

Name	Machine	Manual	PPC Filter	RO Filter	Raw water tank
Quantity	1 set	1	1 set	1 set	1 set

■ Instructions For Use

4. Whole Machine Installation

4.1 Flushing The Filter Cartridges

The filter cartridges need to be rinsed before use. Remove the raw water tank from the machine, take out the foam pad at the bottom of the filter cartridge, add municipal tap water that meets the standard to the raw water tank, the water volume should not exceed the maximum water level line, and then put it on the machine to hear a "click", and close the cap. If there is no abnormality, plug in the power plug, and the water purifier starts water purification (the corresponding indicator flashes). Place a container larger than 1.5L under the water outlet for draining water. Press and hold the  water output button for 3 seconds, and hear a beep. At this time, only the  water output button is flashing, and other buttons are not displayed, and the drainage has started. After the water is drained, repeat the above process three times, and return to the normal mode again, then the machine can be used normally.

4.2 Placement

The water purifier must be placed on a fixed and flat surface. Do not put it in direct sunlight which will affect the appearance.

4.3 Connect Power Supply

Before inserting the power cord plug into the power socket, please confirm that the input voltage is 220V, the minimum current of the socket is greater than 10A, and keep the power plug and hands dry.



Notice

If the power cord is damaged, it must be replaced by a professional from the manufacturer, its maintenance department or similar department in order to avoid danger.

■ Instructions For Use

5. Product use

5.1 Boot

Plug in the power cord, the whole machine emits a beeping sound, and at the same time, all the contents on the display screen light up for about 1 second, and then it enters the normal display state, the machine starts to purify water.

5.2 Operation buttons and indicator lights

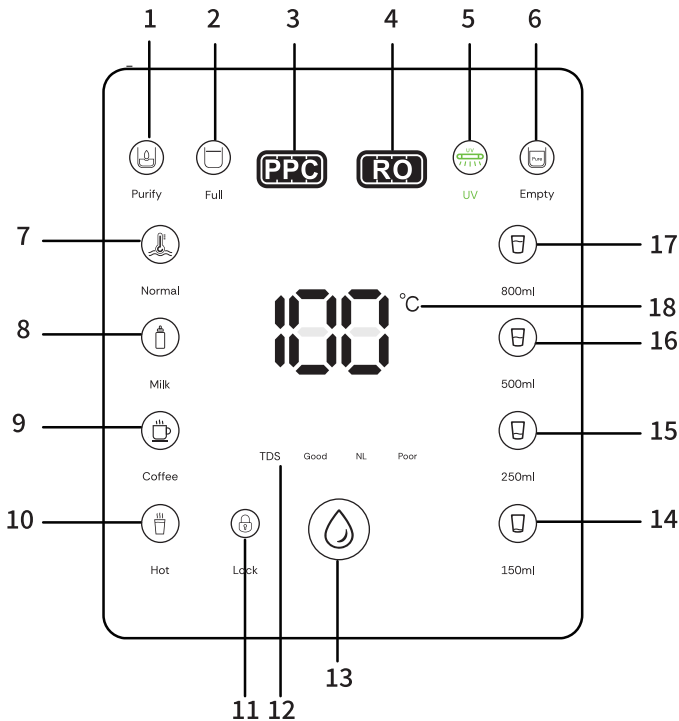

- | | |
|--|--|
| 1. Water Purifying Indicator | 2. Interior Pure Water Tank Full Indicator |
| 3. PPC Composite Filter Cartridge Life Indicator | |
| 4. RO Filter Cartridge Life Indicator | |
| 5. UV Indicator | 6. Water Shortage Indicator |
| 7. "Normal" button | |
| 8. "Milk" button | 9. "Coffee" button |
| 10. "Hot" button | |
| 11. Child Lock Button | 12. TDS Value Display |
| 13. Water output button | |
| 14. 150ml Volume Button | 15. 250ml Volume Button |
| 16. 500ml Volume Button | |
| 17. 800ml Volume Button | 18. Water Temperature Display |

■ Instructions For Use

6. Indicator Light Description

6.1 Water Purifying Indicator light

Water Purifying indicator light up when the water level in the pure water tank is lower than the maximum water level, the machine starts to purify water. During this time, the Water Purifying indicator flashes until the water purification is completed.

6.2 Interior Pure Water Tank Full Indicator light

When the pure water tank is not full, the Interior Pure Water Tank Full Indicator light is off; when the pure water tank is full, the indicator light stays on.

6.3 PPC Composite Filter Cartridge Life Indicator light

While the life of the PPC composite filter cartridge has not expired, the default light is always on. When the life of the PPC composite filter cartridge expires, the white indicator light will flash quickly (the machine can still be used after the filter cartridge expires, but the buzzer will sound four times each time the water is taken). After the filter cartridge replacement is completed, press and hold the "150ml" button for 5 seconds, and the filter cartridge will be reset.

6.4 RO Filter Cartridge Life Indicator light

While the life of the RO filter cartridge has not expired, the default light is always on. When the life of the RO filter cartridge expires, the white indicator light will flash quickly (the machine can still be used after the filter cartridge expires, but the buzzer will sound four times each time the water is taken). The RO membrane After the filter cartridge replacement is completed, press and hold the "250ml" button for 5 seconds, and the filter cartridge will be reset.

6.5 UV Indicator light

When the UV lamp is in operation, the UV indicator lights up in green colour on display. When machine is purifying water, the UV indicator lights up. UV lamp and indicator will continue to work for 15 minutes after each water purification. Every 6 hours it will work for 15 minutes.

6.6 Pure Water Shortage Indicator light

When the interior water tank reaches the low water level, the Pure Water Shortage indicator lights on, and the machine cannot dispense water. The buzzer sounds at the same time.

Once the water exceeds the low water level in the interior water tank, the indicator's light turns off.

■ Instructions For Use

6.7 TDS Value Display

TDS (Total Dissolved Solids) is a general term for inorganic salts and heavy metals dissolved in water.

The lower the TDS value, the higher the water quality.

TDS value: excellent ≤ 80 (green text "Good" is displayed), indicating that the TDS value in the pure water tank is low and the water quality is great;

TDS value: good $\geq 80 \sim \leq 150$ (yellow text "NL" is displayed), indicating that the TDS value of water in the pure water tank is normal;

TDS value: difference ≥ 150 (red text "Poor" is displayed), indicating that the water in the pure water tank needs to be replaced;

6.8 Water Temperature Display

After turning on the power, displays the corresponding output water temperature, or displays the corresponding fault code when there is a fault.

7. Button Description

7.1 Water Output Button

Press the  Water output button to output water, and the second press stops the water flow. While the water is outputting, the white indicator light of the Water output button will flash; after the water flow has stopped, the white light stays on and the buzzer sounds.

7.2 "Normal" Temperature Button

Normal temperature water (displays 25°C): By default, when powered on the "normal" temperature mode is always selected, and the button text light flashes. Press the "Normal" Temperature button, the "Normal" Temperature text light will flash, and the "Normal" Temperature text light will keep flashing after the water flow has stopped.

7.3 "Milk" Temperature Button

Milk temperature water (displays 45°C): The button icon and text light are always on when powered on.

Press the "Milk" Temperature button, and the "Milk" Temperature text light will flash, and it will keep flashing after the water flow has stopped.

7.4 "Coffee" Temperature Button

Coffee temperature water (displays 85°C): The button icon and text light are always on when powered on.

Press the "Coffee" Temperature button, and the "Coffee" Temperature text light will flash, and it will keep flashing after the water flow has stopped.

7.5 "Hot" Temperature Button

Hot temperature water (displays 100°C): The button icon and text light are always on when powered on.

Press the "Hot" Temperature button, and the "Hot" Temperature text light will flash, and it will keep flashing after the water flow has stopped.

■ Instructions For Use

7.6 "800ml/500ml/250ml/150ml" Volume Buttons

"800ml/500ml/250ml/150ml" button icons are always on when powered on. By default, when powered on the "150ml" water volume is always selected, and its text light flashes. Select each water volume button, and the button text light will flash, and it will keep flashing after the water flow has stopped.



Note

When the machine is powered on for the first time or after sleeping mode, the default water volume and temperature are set to 150ml and normal temperature respectfully.

Sleeping mode: after 60 seconds of inactivity, the machine enters sleeping mode - all buttons except child lock are switched off. Sleeping mode is deactivated by pressing on any button.

8. Child lock function

The Child Lock button's light is always on. Red light represents the locked state and white light - unlocked state. After the button is unlocked, the button functions can used normally.

- When the temperature mode is < 50°C, Child Lock button lights up white. The water can be dispensed immediately. The Child Lock button does not need to be unlocked.

- When the temperature mode is ≥ 50°C, Child Lock button lights up red. The water can only be dispensed when the Child Lock button is unlocked and lights up white. 10 seconds after the water has been dispensed or after 10 seconds of inactivity, the Child Lock button activates itself and lights up red.

Press the Child Lock button continuously for 3 seconds to cancel the child lock function in the child lock cancel mode. To restore child lock function, press the Child Lock button 3 times in a row.

9. Altitude boiling point adjustment

When at high altitudes, the boiling point of hot water will change, please use the temperature adjustment mode when needed. The machine's default boiling point is 93°C; To enter the boiling temperature adjustment mode, within 10 seconds of powering on the machine, press and hold the "Milk" + "500ml" buttons for 3 seconds, then you can press the "Milk" and "500ml" buttons to adjust the maximum water temperature (press the "Milk" button to decrease, press the "500ml" button to increase), the adjustment range is 81°C-93°C. 10 seconds after selection, the mode automatically exits, saves when power off, and takes effect after power on again.

10. Pure water tank cleaning mode

When the pure water tank is full or not full of water, press and hold the  Water output button for 3 seconds, the buzzer will sound for 1 second, the water output button light will flash, the other lights will go out, the machine will stop water purification. During cleaning mode, the water pump will not stop until the water tank is emptied and it continues to work for 15 seconds. After the water is drained, it will automatically return to the normal working mode.

11. Reset

Within 10 seconds after starting up, press and hold the "Normal" Temperature + "800ml" buttons simultaneously for 2 seconds. The buzzer will sound for 2 seconds and all indicators will light up for 2 seconds. The factory parameters will be restored. After the factory settings are successfully restored, all indicators will return to normal. In normal working status, the buzzer sounds for 2 seconds.

Care & Maintenance

1. Instructions

1.1 Use of the raw water tank

Remove the raw water tank cover (Figure 1), lift the raw water tank upwards (Figure 2), pour out the remaining water in the raw water tank and fill it up with water. After that, put it back on the water tank seat (Figure 3), and put on the cover (Figure 4).

Note: The water level in the raw water tank should not exceed the maximum water level line.

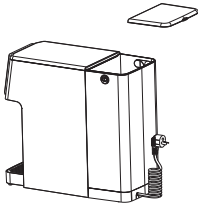

(Figure 1)

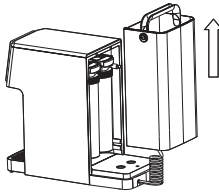

(Figure 2)

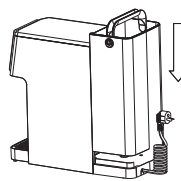

(Figure 3)

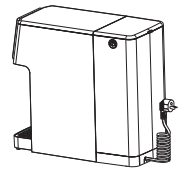

(Figure 4)

1.2 Filter replacement method

Take off the raw water tank cover (Figure 5), remove the water tank (Figure 6), lift up the filter cartridge buckle, take out the filter cartridge, insert the new filter cartridge in place, and press the buckle down in place (Figure 7),

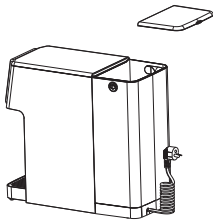

(Figure 5)

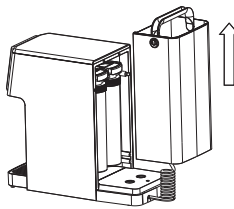

(Figure 6)

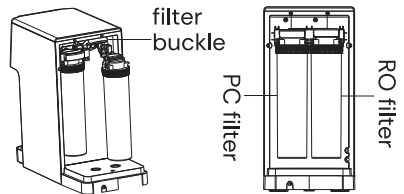

(Figure 7)

2. The filter cartridge is a consumable and is not covered by the warranty:

Filter cartridge	Filter cartridge name	Recommended replacement cycle
First stage	PPC composite filter cartridge	8~12 months
Second stage	RO membrane filter cartridge with mineralization	12~24 months

■ Care & Maintenance

After each filter cartridge is used for a long period of time, various impurities will accumulate in the cartridge, affecting the water output speed.

In order to maintain normal water output, the filter cartridge should be replaced regularly:

1. In areas with poor water quality or high water consumption, the replacement cycle of the filter cartridge will be shortened.
2. The water quality in different places is different, and the service life of the filter cartridge will be different.
3. The above filter cartridge replacement cycle does not refer to the quality guarantee period of the filter cartridge, but the estimated use period during which the filter cartridge maintains its original performance. If the filter cartridge is not replaced regularly, the purification quality of the machine may be reduced.
4. When the filter cartridge life icon on the machine display flashes, the filter cartridge needs to be replaced.

Fault alarm description

Failure code	Reason
Water purification timeout fault E1	If the pure water tank float has not reached the high-water level after the machine has continuously produced water for 30 minutes, it indicates a water purification failure. The buzzer will sound and the display will flash the fault code E1. The machine is prohibited from purifying and discharging water. The power must be cut off to resolve the fault. Restart the machine before you can continue using.
Water outlet NTC fault E2	If the water outlet NTC is not plugged in or is short-circuited. The buzzer will sound and the display will flash the fault code E2. The machine prohibits water purification and water output. The machine must be powered off to resolve the fault and then restarted to continue using.
Water ingress NTC fault E3	If the water inlet NTC is not plugged in or is short-circuited, the buzzer will sound and the display will flash the fault code E3. The water machine is prohibited from purifying and dispensing water. The machine must be powered off to resolve the fault and then restarted to continue using.
Thick film heating tube failure E4	If the thick film heating tube does not heat, the buzzer sounds, the display flashes the fault code E4, the machine is prohibited from purifying and dispensing water, and the machine must be powered off and restarted to resolve the fault, to continue using.
Raw water shortage fault E5	If the raw water tank is short of water, the buzzer sounds twice and the display flashes the fault code E5. After the raw water tank is filled with water, the machine can continue to work.

■ Troubleshooting

Before requesting maintenance, please check the following points:

Phenomenon	Possible Reason	Solution
Water purifier does not output water	<ol style="list-style-type: none"> 1. The main unit is not powered on. 2. The raw water tank is not installed properly. 3. The filter cartridge is clogged. 4. The raw water tank is short of water. 	<ol style="list-style-type: none"> 1. Power on the main unit. 2. Install the raw water tank in place. 3. Replace the filter cartridge. 4. Replace the raw water.
Water Flow Is Slow	<ol style="list-style-type: none"> 1. The filter cartridge has reached the end of its life. 2. The voltage is not compatible to the value marked on the nameplate. 3. The booster pump is not working. 4. The water temperature is too low. 	<ol style="list-style-type: none"> 1. Replace the filter cartridge. 2. Change to a power supply that matches the rated voltage. 3. Check whether the booster pump is working. 4. Increase the raw water temperature.
Water purifier not producing hot water	<ol style="list-style-type: none"> 1. After selecting the water temperature button, the water output button is not clicked. 2. The water level of the pure water tank is lower than the low water level. 	<ol style="list-style-type: none"> 1. Select the water temperature button and then press the water output button. 2. Wait until the pure water tank reaches the high water level before taking hot water.
Peculiar Smell	<ol style="list-style-type: none"> 1. The filter cartridge has exceeded its service life. 2. The water purifier has not been used for a long time. 	<ol style="list-style-type: none"> 1. Replace the filter cartridge. 2. Activate cleaning mode.

If there are other faults, since special tools are required, it must be repaired at the designated maintenance point or please contact the official after-sales customer service for guidance.

Waterway Map

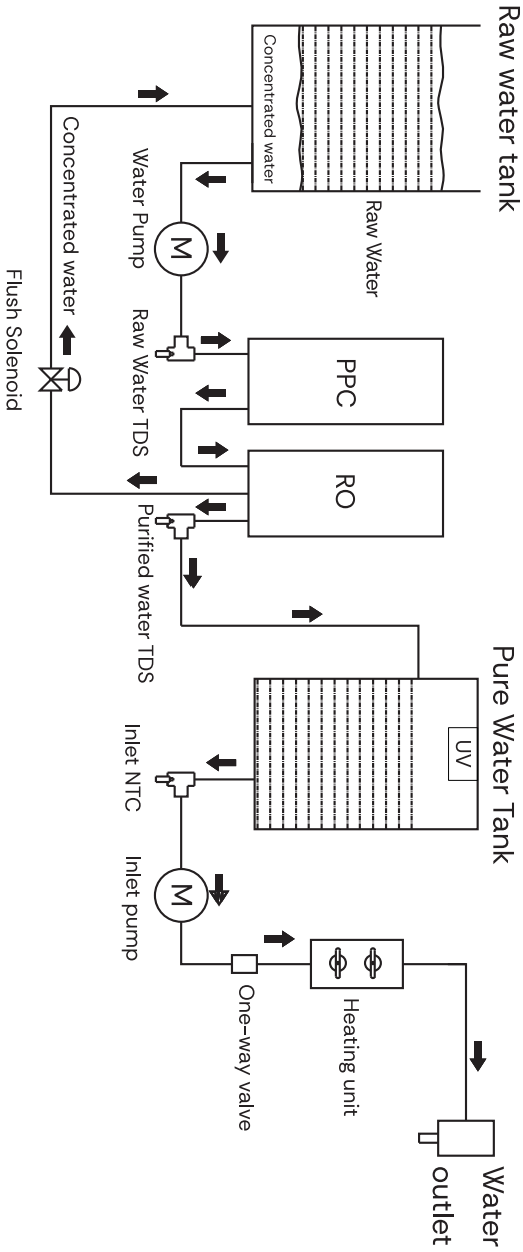

■ Product Specifications

Technical Parameter

Product name	Reverse Osmosis Water Purifier
Model	FreshGO Flex
Product number	OF-F24001
Rated power	220V/50Hz
Heating system rated power	2200W
Applicable water source	Municipal tap water
Applicable environment	4~40°C
Work stress	0.4-0.7MPa
Applicable water temperature	5~38°C
Net water flow	0,2L/min
Hot water capacity (≥90°C)	20L/h
Rated water production	2000L
Raw water tank capacity	6L
Dimensions	405mm x 185mm x 380mm
Weight	7.5kg
PC Composite Filter	Removes coarse particles, heavy metals etc.
UV Sterilization	Removes bacteria etc.
RO Membrane Filter	Removes up to 99,99% of pollutants

OasisPure

info@oasispure.eu

For more information, visit us on: <https://oasispure.eu/>